

CAD Tutorial

In this tutorial you'll learn about:

- CAD Detail Windows
- Exploding and Modifying a CAD Block
- Creating a New CAD Block
- CAD Detail from View
- Creating a Plot Plan

CAD Detail Windows

CAD Details are special view windows for drawing, saving, and organizing any 2D drawings associated with the current plan, such as section details, plot plans, and schedules. Like other views, CAD Details are saved with the plan or layout they are created in and can be printed. If a CAD Detail is created in a plan file, it can also be sent to layout at a specified scale. See “Sending Views to Layout” on page 1222 of the Reference Manual.

To create a new CAD Detail window

1. Select **CAD> CAD Detail Management**  to open the **CAD Detail Management** dialog. An alphabetical list of all CAD Details saved with the current plan displays on the left side of the dialog.
2. Click **New** to open the **Create New CAD Detail** dialog.
3. Type a short, descriptive name for the CAD Detail, such as "Foundation & Wall Detail" then click **OK** to open a new, blank CAD Detail window.

Your new CAD Detail window is ready for you to add CAD objects, text, dimension lines, schedules, and more.

Exploding and Modifying a CAD Block

CAD Detail windows are an excellent place for you to draw and organize your detail drawings. Drawings like foundation details can be created from scratch using the CAD Tools, but you can also save time by choosing a CAD block from the library, placing it into a CAD Detail window, and then modifying it to suit your needs.

A CAD block simply is a group of 2D CAD objects, text objects, and/or other CAD blocks that have been grouped together so that they behave as a single object when selected.

To place a CAD block from the Library Browser

1. Select **View > Library Browser**  and either search or browse to locate a CAD block.
 - For this tutorial, the "Basement Foundation: Finished 4" CAD block from the CAD Blocks and Details Bonus Catalog is used. For information about obtaining Bonus libraries, see "Downloading Library Content" on page 819 of the Reference Manual.
2. Select the CAD block in the library and then click in the CAD Detail window to place it at that location.

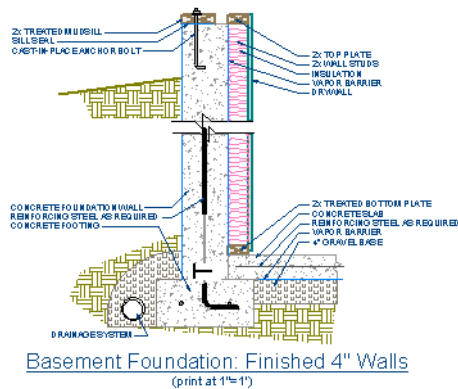

 A selection of CAD Details is available in the Chief Architect Core Catalogs, however, additional CAD Details can also be downloaded from the website.

As with other objects, CAD blocks can be selected and edited. A few of the available editing methods are described in this tutorial, and more information can be located in “Editing Objects” on page 101 of the Reference Manual.



Reflecting a CAD Drawing

Like other objects, CAD blocks can be reflected.

To reflect a CAD drawing

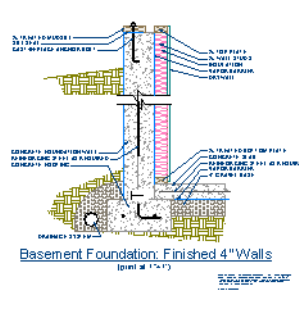
1. Select **CAD> Line> Draw Line** , then create a vertical line to the right of the CAD block.





2. Next, using the **Select Objects**  tool, click to select the CAD block.
3. Click on the **Reflect About Object**  edit tool, then click on the CAD line that you just placed to reflect the CAD block over to the other side of the line.

Exploding a CAD Block

If you click on a CAD block, you will notice that the entire CAD block is selected. This allows you to easily move, rotate, reflect, or copy and paste the entire object; but it also means that you cannot select its individual elements unless you explode the CAD block.



To explode a CAD block

1. Using the **Select Objects**  tool, click to select the CAD block.
2. Next, click on the **Explode CAD Block**  edit button to explode the CAD block into its separate elements.

Editing the Elements of an Exploded Block

If you click on a CAD block that has been exploded, it will no longer behave like a single object. Instead, each of its elements can be modified independent of the others.

To move an edge of a closed polyline using dimensions

1. **Zoom**  in on the lower portion of the CAD Detail, and using the **Select Objects**  tool, click on the right side of the lower Concrete filled polyline.
2. Notice that the blue CAD line is selected first. We can **Delete**  that blue CAD line, and again select the right side of the closed polyline.
3. Move your mouse over the Temporary Dimension of 7 5/8". When the pointer turns in to a hand, click to activate the Move Objects Using Dimensions in-line text box. Type in an exact value of 8" and press Enter on the keyboard to apply this change.

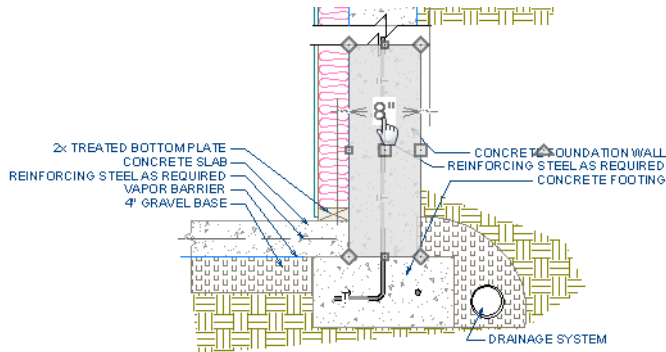

Basement Foundation: Finished 4" Walls

4. Repeat this process on the upper closed polyline with the Concrete Fill Style applied so that both are 8".

Once the rectangular closed polylines with the Concrete Fill Style have been resized, they overlap other polylines.

To display an object behind all other objects

1. Select the upper right closed polyline that is overlapping, and click on the **Open Object**  edit tool.

2. On the Line Style panel of the **Polyline Specification** dialog, in the Drawing Group selection, move the radio button to **Back Group** and click **OK**.

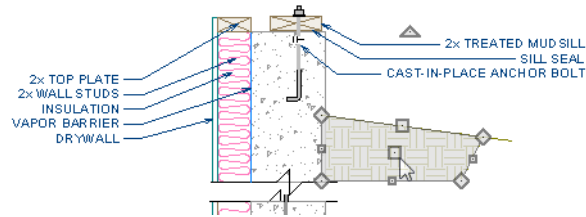



Creating a New CAD Block

A CAD block can be created from any collection of CAD objects, text, or other CAD blocks - including those that originally came from a CAD block that was exploded. CAD blocks can also be added to the library for future use.

Specifying an Insertion Point

By default, a CAD block will have a placement snap point, referred to as its Insertion Point, at its center. You can specify a custom Insertion Point to make it easy to place the drawing with precision using a particular feature as a reference instead of its center point.

To specify insertion point locations

1. Select **Edit> Snap Settings** and make sure that all **Object Snaps**  are enabled. See “Object Snaps” on page 162 of the Reference Manual.
2. Select **CAD> Points> Place Point**  then click on the top right corner of the rectangular polyline representing the concrete footing to place a point at that location.

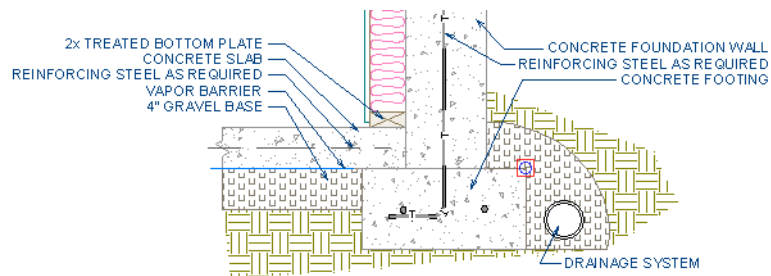



3. Place a second CAD Point  at the upper portion at the top right corner of the polyline representing the concrete stem wall. For more information, see “Select Insertion Point” on page 1091 of the Reference Manual.

Blocking and Adding the Library



Once a CAD drawing has everything it requires to meet your needs, you can block it; and, if the drawing is one that you can use for other projects, you can add it to the library for future use.

Here, we will create a CAD block composed of two nested blocks with custom insertion points.

To create a CAD block and add it to the library

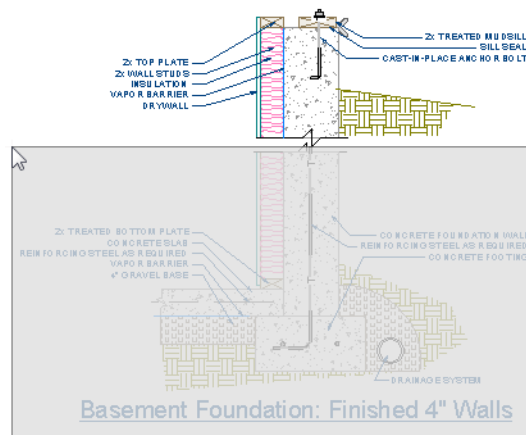

1. First, let's set up our Preferences so it is easy to select two portions of our CAD drawing separately. Select **Edit> Preferences** , and choose the Edit panel.
 - Under Marquee Selection, click the radio button beside **Select Contained Objects**, then click **OK**. See “Edit Panel” on page 109 of the Reference Manual.
2. Select **Window> Fill Window** .
3. Using the **Select Objects**  tool, click and drag a marquee around the lower section of the detail drawing.

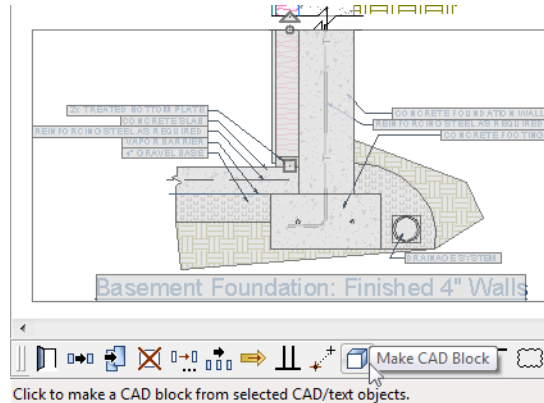

4. Click the **Make CAD Block**  edit button to block all of the selected text, lines, and polylines in to a single CAD block.
5. With the CAD block selected:
 - Click the **Select Insertion Point**  edit button.

- Move your mouse pointer over the top right corner of the concrete footing and when you see the Endpoint snap indicator, click once.
 - The CAD block's Move edit handle will now display at the location of its custom Insertion Point.
6. Repeat this process with the upper portion of the drawing.





7. Now, group select both upper and lower CAD blocks and use **Make CAD Block**  edit tool to block them together, forming a single CAD block composed of two nested blocks.
8. Finally, click the **Add to Library**  edit tool to add it to the User Catalog in the library. You can then rename it and move it in to a folder to suit your organizational style. See “Adding Library Content” on page 821 of the Reference Manual.

CAD Detail from View

CAD Detail from View is a powerful feature that converts the current line-based view into a 2D CAD drawing located in its own CAD Detail window. This drawing is composed of CAD lines, arcs, and polylines that you can edit, and is no longer dynamically linked to the model. For more information, see “CAD Detail from View” on page 1098 of the Reference Manual.

To create a CAD Detail from View

1. In floor plan view, select **3D> Create Orthographic View> Backclipped Cross Section** , then click and drag a camera arrow within the interior of the structure.
 - Keep in mind that this type of view will only include objects or portions of objects located between the starting and stopping points of the camera's Line of Sight.

- For more information, see “Cross Section/Elevation Camera Tools” on page 894 of the Reference Manual.
2. Select **Tools> Layer Settings> Display Options** , and turn off the display of any layers that you do not need for the purposes of a foundation wall detail, such as all fixtures, furnishings, and cabinets, then click **OK**.
 3. Zoom in on the right corner of the basement.
 4. Next, select **CAD> CAD Detail from View**  to convert the current view in to a 2D CAD drawing in a new CAD Detail window.
 5. The new CAD Detail window will become the active view and you can edit it to suit your needs. For more information, see “CAD Details” on page 1097 of the Reference Manual

Adding and Positioning a CAD Block

Now we are ready to insert the modified foundation CAD Block into the CAD Detail and precisely position it.

To add and position the CAD block

1. **Zoom**  in on the CAD Detail that represents the lower right portion of the foundation wall.
2. Next, in the Library Browser, browse to your custom modified CAD Block, select it, and click in the view to place it.

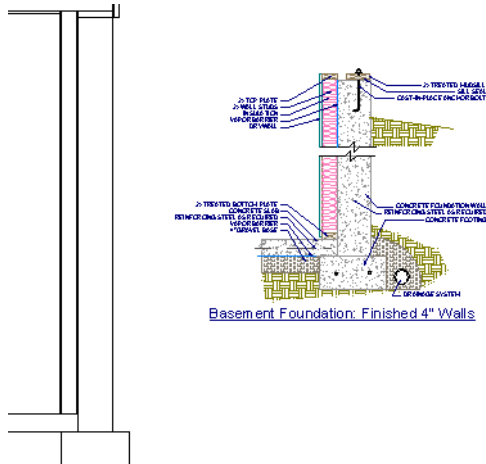

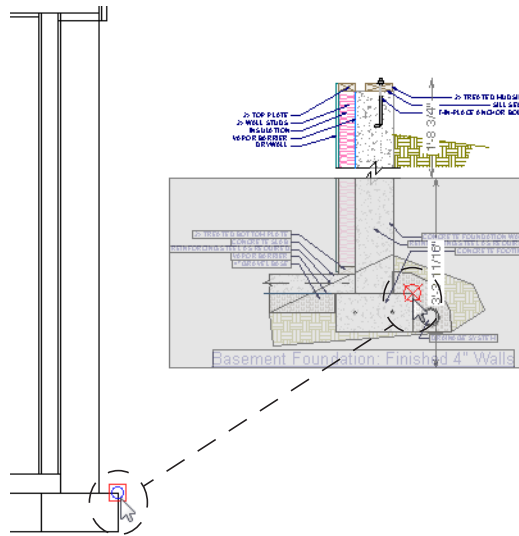

3. Select the CAD Block and click on the **Explode CAD Block**  edit tool.

4. Select the lower CAD Block and use its end handles to move it until it snaps into position over the CAD lines representing the footing in the larger drawing.
5. You can also use the **Point to Point Move**  edit tool to do this. First, click on the CAD block's Insertion Point, then click on the top right corner of the CAD lines representing the footing in the larger drawing. For more information, see "Point to Point Move" on page 221 of the Reference Manual.

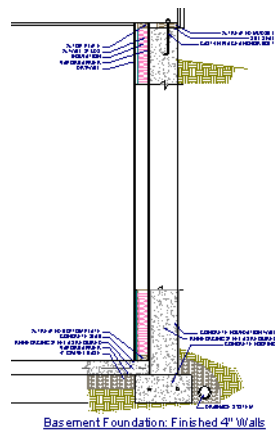

6. Repeat this process to place the upper CAD block.



7. The Layout Tutorial discusses how to send views such as this one to layout, so make sure to **Save**  your plan.



Creating a Plot Plan

A plot plan is essentially a map of a property's legal description. Plot plans usually have a North Pointer and can also include other features such as the location of buildings and setback lines.

When a property's shape is more complicated than a basic rectangle, you may find it easiest to draw the plot lines yourself, rather than try to edit the terrain perimeter to meet your needs.

A plot plan can be drawn in floor plan view or, if you prefer, in a CAD Detail. See "CAD Detail Windows" on page 179.

To create a CAD Detail for the plot plan

1. If you want to draw your plot plan in a CAD Detail, select **CAD> CAD Detail Management**  and click **New**.
2. Type a short, descriptive name for your detail, such as "Plot Plan" and click **OK**.
3. Select **Tools> Default Settings** , and in the **Default Settings** dialog, double-click on "Active Defaults" in the tree list.

4. In the **Active Defaults** dialog:

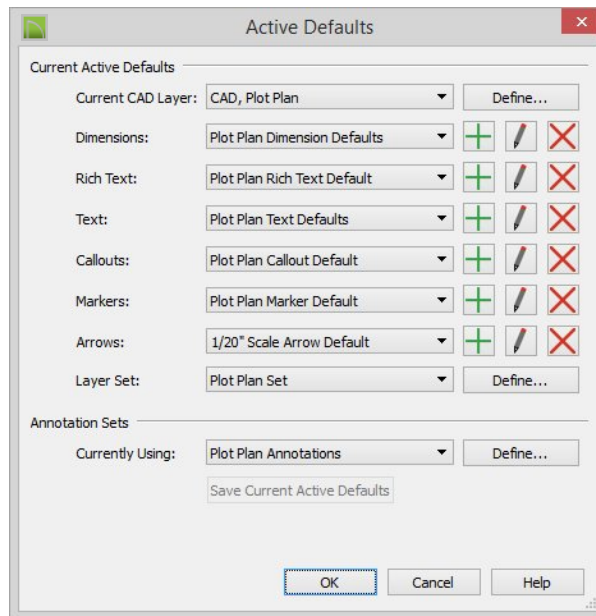



- Select "Plot Plan Annotations" from the **Currently Using** drop-down list.
 - Notice the changes to the **Current Active Defaults** settings. They now set to use defaults designed for drawing plot plans.
 - Click **OK** to close the dialog and apply these changes to the current view.
5. When to the CAD Detail window, notice that Plot Plan Annotations is selected in the Active Annotation Set Control in the toolbars. For more information, see "Annotation Sets" on page 78.

To create a plot plan polyline

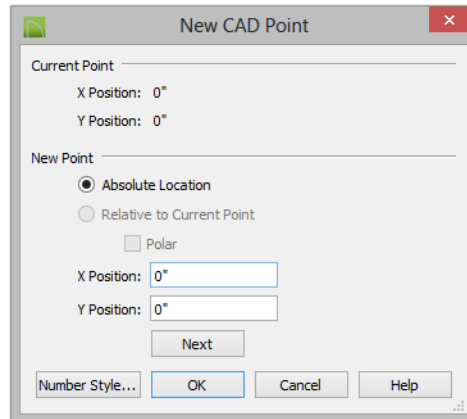
1. Select **CAD> Points> Input Point**  to open the **New CAD Point** dialog. See “Input Point” on page 1055 of the Reference Manual.



2. Select **Absolute Location** and define the point's position at (0,0) and click **OK**. This is the current point that serves as the Start Point for the first line of the plot plan. See “Point Tools” on page 1054 of the Reference Manual.
3. Select **CAD> Lines> North Pointer** , then click and drag to create a North Pointer. For more information on this tool, see “North Pointer” on page 931 of the Reference Manual.
4. Select **CAD> Lines> Input Line**  to open the **New CAD Line** dialog. Notice that the Start Point is at (0,0): the location of the Current CAD Point. See “Input Line” on page 1059 of the Reference Manual.
5. Click the **Num Style** button and in the **Number Style/Angle Style** dialog:
 - Select **Decimal Feet** for the **Number Style**;
 - Select **Quadrant Bearing** for the **Angle Style**. See “Dialog Number/Angle Style Dialog” on page 126 of the Reference Manual.
6. Click **OK** to return to the **New CAD Line** dialog
7. Select **Relative to Start Point** and check the box beside **Polar**.
8. Enter the length of the first side of your property boundary's legal description in the **Distance** field, and the angle of that line in the **Angle** field. To enter an angle using Quadrant Bearings, type:
 - The primary direction (N or S), followed by a space; then,
 - The angle in degrees, minutes, and seconds with a space after each value; then,



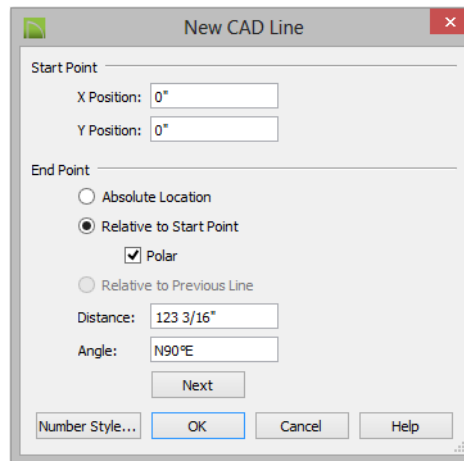

- The secondary direction (E or W).





9. Click **Next** and enter the **Distance** and **Angle** of the next property line.
10. Continue until all property lines are entered, then click **OK** to close the **New CAD Line** dialog. The resulting polyline should be closed, with the end point of the last line the same as the start point of the first.

Note: The angle of a given line can be described differently depending on which end is used as the start point. Some property descriptions proceed in the same direction around the perimeter, whereas some do not.

To correct an error



1. If a line is entered incorrectly, click **OK** to close the **New CAD Line** dialog.
2. Select **Edit> Edit Behaviors> Edit Object Parts**  to edit individual line segments within a polyline.
3. Click on the incorrect line to select it, then click **Delete** .
4. Click the **Edit Object Parts**  toggle button again to turn it off.
5. Place a CAD point at the end of the last correct line using the **Place Point**  tool to create a new current point.
6. Select **CAD> Lines> Input Line**  and continue entering data in the **New CAD Line** dialog.

To create a curved property line

1. Click a property line to select it, then click the **Change Line/Arc**  edit button to turn this line into an arc.
2. If necessary, use the triangular Reshape edit handle to make the arc concave or convex.
3. Click the **Open Object**  edit button to open the **Polyline Specification** dialog.
4. On the Selected Arc panel, click the **Lock Chord** radio button, then specify the length of the **Radius** and click **OK**.



 A curved property line can also be created by entering data in the New Arc dialog. See "Input Arc" on page 1069 of the Reference Manual.

To display line length, bearing and radius

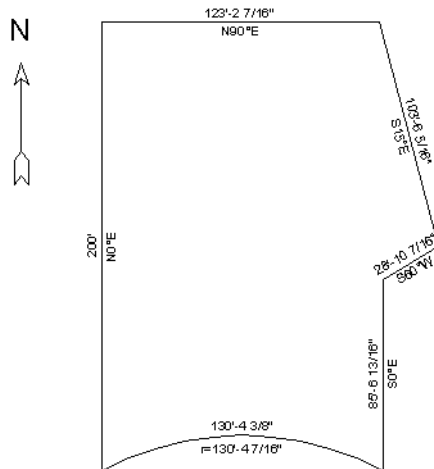
1. Select **Edit> Default Settings** .
2. In the **Default Settings** dialog, select CAD and click the **Edit** button.
3. In the **CAD Defaults** dialog, check **Display Line Angle as Quadrant Bearing**.
4. Click **OK**, then click **Done** to close the **Default Settings** dialog, as well.
5. Click the plot plan polyline to select it, then click the **Open Object**  edit button.
6. On the Line Style panel of the **Polyline Specification** dialog, check **Show Length, Show Angle**, and **All Angles**.



To create setback lines

1. Select **Edit> Preferences** , and on the Behaviors panel of the **Preferences** dialog, select the **Concentric** Edit Mode. See “Behaviors Panel” on page 111 of the Reference Manual.
2. In the **Jump** field, type in the required setback distance, such as 10’, and click **OK**.
3. Click the plot plan polyline to select it, then click the **Copy/Paste**  edit button.
4. Place your cursor over a corner edit handle, then click and drag towards the center of the polyline. When a second, inner polyline appears, release the mouse.
5. Select the inner polyline and click the **Open Object**  edit button to open the **Polyline Specification** dialog.
6. On the Line Style panel, select a dashed line style from the drop-down list, uncheck **Show Length** and **Show Angle**, then click **OK**.

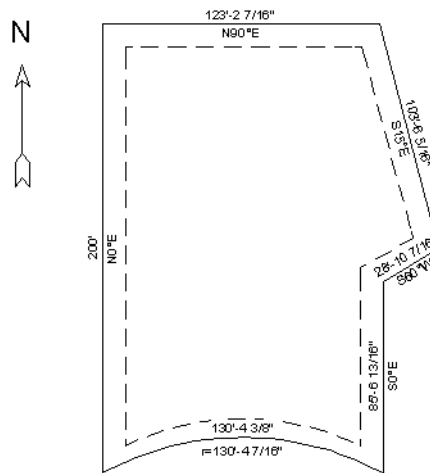

7. When you have finished creating your concentric copy, select **Edit> Edit Behaviors> Default**  to restore the default edit behavior.

To place the setback polyline on a new layer

1. Select **Tools> Layer Settings> Display Options**  to open the **Layer Display Options** dialog.
2. Click the **New** button at the bottom of the dialog to open the **New Layer Name** dialog. Type a short, descriptive name such as "Lot Line Info", then click OK.
3. Click OK to close the **Layer Display Options** dialog.

4. In floor plan view, select the setback line and click the **Open Object**  edit button.
5. On the Line Style panel of the **Polyline Specification** dialog, click the **Layer** drop-down list and select the new layer you just created, then click OK.

To add a Plan Footprint to your Plot Plan

1. Select **CAD> Plan Footprint** . In the **Plan Footprint** dialog, a drop-down list allows you to select the Floor you want to create your plan footprint from.

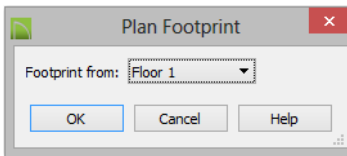

2. Select a floor, then click **OK** to create a CAD object representing the building footprint in the CAD Detail window. See “Plan Footprint” on page 1099 of the Reference Manual.
3. You can control what information displays in the Plan Footprint selecting it and clicking the **Open Object**  edit button. On the General panel:

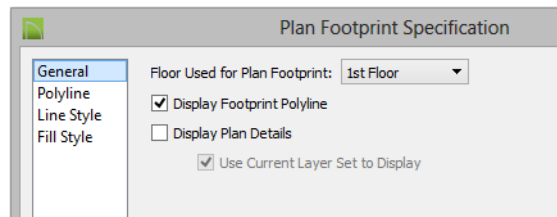



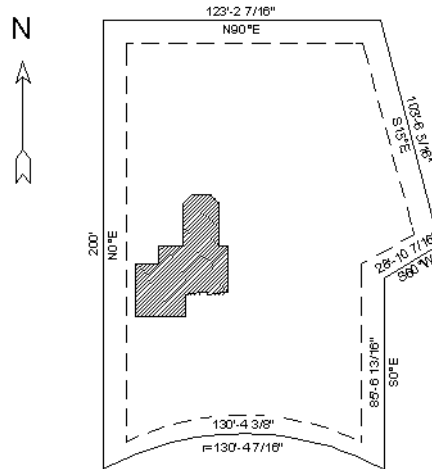

- Uncheck both **Use Current Layer Set to Display** and **Display Plan Details**;
 - Check the box beside **Display Footprint Polyline**.
4. On the Fill Style panel, select **Angle Hatch** from the drop down menu, and set the spacing to 15", then click **OK** to apply the changes.

- The Plan Footprint can be moved into place on the Plot Plan using its edit handles or edit tools.



To convert to a terrain perimeter

In order to create a terrain perimeter out of your plot plan, it must be copied from the CAD Detail in to your floor plan view.

- Using the **Select Objects**  tool, click on the CAD polyline that forms the perimeter of your plot plan in the CAD Detail window and select **Edit> Copy** .
- Next, click the window tab associated with the floor plan view to activate it, and go to Floor 1.
- Select **Edit> Paste> Paste**  then click in the drawing area to place a copy of the polyline.
- Select the newly pasted plot plan polyline and click the **Convert Polyline**  edit button. See “Convert Polyline” on page 237 of the Reference Manual.
- In the **Convert Polyline** dialog, select **Convert To: Terrain Perimeter**, then click **OK**.

 If Terrain Perimeter is greyed out as an option, then a Terrain Perimeter already exists in your floor plan which you will need to locate and delete before you can convert the polyline.

- Make any needed changes in the **Terrain Specification** dialog and click **OK**. See “Terrain Specification Dialog” on page 725 of the Reference Manual.

7. To increase the size of the text displayed along the Terrain Perimeter polyline, select **Tools> Layer Settings> Display Options** .
8. In the Layer Display Options dialog, scroll down to the Terrain Perimeter layer, and use the drop down menu to change the Text Style from the default to the **Plot Plan Text Style** and click **OK**.

To accurately position a building

1. Select **CAD> Point> Place Point** , and then click at a reference point along the perimeter of the building, such as at a corner.

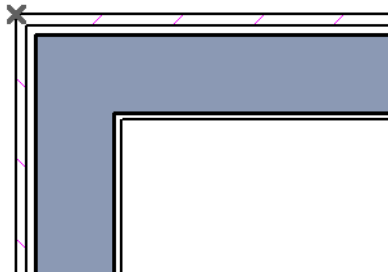

2. Select **CAD> Points> Input Point**  to open the **New CAD Point** dialog.
 - Select **Relative to Current Point**;
 - Using the **X Position** and **Y Position** fields, specify the distance that a known point on the property line should be from the Current CAD Point on the building perimeter. Unless you want to specify the location in distance and bearing, **Polar (CCW from horz)** should remain unchecked.
 - Unless you want to specify the location in distance and bearing, **Polar (CCW from horz)** should remain unchecked.
3. When you click **OK**, a point is created at the specified location. Use this point as a reference to accurately position the Terrain Perimeter polyline.